



Electric-TOWER of POWER™

Temperature Control Module

Overview, Assembly, Operation & Maintenance

Congratulations on your purchase, and thank you for selecting the Electric TOWER of POWER™ temperature control module from Blichmann Engineering™. We are confident that it will provide you years of service and many gallons of outstanding beer. This manual will familiarize you with the assembly, operation, and maintenance of the Electric TOWER of POWER™ temperature control module.

IMPORTANT!!

**** PLEASE READ THOROUGHLY PRIOR TO USE FOR IMPORTANT SAFETY INFORMATION ****

Warning: Sections labeled "Warning" can lead to serious injury or death if not followed. Please read these thoroughly and understand them completely before use. If you do not understand them or have any questions, contact your retailer or Blichmann Engineering™ (www.BlichmannEngineering.com) before use. Do NOT at ANY time operate the product until you thoroughly read and understand these instructions!

Caution: Sections labeled "Caution" can lead to equipment damage or unsatisfactory performance of the equipment. Please read these sections thoroughly. If you have any questions, contact your retailer or Blichmann Engineering™ (www.BlichmannEngineering.com) before use.

Important: Sections labeled "Important" are critical to the proper performance and life of the product.

Overview:

The Electric TOWER of POWER™ temperature control module is an ideal means to safely and accurately control the temperature of your boil kettle, mash tun, or hot liquor tank. Additionally, the Electric TOWER of POWER™ electric control module is perfectly suited for controlling the power output of your BoilCoil™ electric immersion heater or RIMS Rocket™ electric recirculation heater.

The Electric TOWER of POWER™ temperature control module is, by design, modular. You can use a single control module for controlling your mash tun or dual temperature control modules for simultaneous control of the mash tun and hot liquor tank. The controllers can operate as standalone units or be integrated with the TOWER of POWER™ control module stand, which provides all of the fittings, plumbing, and valves necessary in a single convenient package. The TOWER of POWER™ control module stand is available with or without a RipTide pump should you already own a brewing pump.

Alternatively, the TOWER LTE™ modular controller stand affords an economical system for mounting a single temperature control module as well as a convenient place to locate a RipTide Pump. Additionally, you can mount your Therminator™ wort chiller to the TOWER LTE™. When not in use, the TOWER LTE™ modular control stand breaks down small enough to stow away in a 20 gallon BoilerMaker™ brew kettle.

Note: The hoses and fittings required to connect the TOWER of POWER™ control module stand to the mash tun and brew kettle are not included. If you are a TopTier™ modular brewing stand owner, an optional mounting kit is available to mount the TOWER of POWER™ control module stand permanently to the TopTier™ modular brewing stand.

Power Requirements

The TOWER of Power Temperature control module is available in either 120VAC or 208/240VAC in either single or dual element capacities. All units must be connected to the appropriate sized GFCI circuit. Refer to the chart to determine the appropriate breaker required for your circuit. If you are uncertain about the power requirements or your service location, contact a licensed and qualified electrician familiar with National Electrical Code standards and requirements.

Unit	Number of Elements	Maximum Heater Power (Watts)	GFCI Breaker Size (minimum)
120VAC	1	2400	20A
208/240VAC Single	1	7200	30A
208/240VAC Dual	2	12000	50A
208/240VAC Dual	2	14400	60A

Important:

The power output of a 240V heater will be approximately 75% of the rated power when operated at 208V.

Warning:

Read and understand all instructions and safety precautions before using the TOWER of POWER™ temperature control module. If you are uncertain about any portion of this manual, contact your Blichmann Engineering retailer or Blichmann Engineering.

Warning:

The Electric TOWER of POWER™ temperature control module must only be used with a GFCI protected power source. Failure to use a GFCI protected power source can result in injury or loss of life.

Warning:

The Dual Element TOWER of POWER must be used with a single temperature probe installed in a single kettle with two heating elements, no more than 7200 Watts each. Do not connect both Power Out cables to a single element. Each Power Out cable must be connected to an individual heating element. Failure to properly connect a single element to each Power OUT cable could result in energizing one of the exposed Power IN cables resulting in electrocution, serious injury, or death. See Figure 3 for Power OUT and Power IN cable identification.

System Requirements

IMPORTANT! Read before unpacking or using this product!

For the TOWER of POWER™ electric modular brewing system to function properly, your brewing system must meet some basic requirements. If your system is unable to meet these requirements please contact your RETAILER for guidance. We cannot guarantee the performance of the product if these basic minimums are not met.

For RIMS brewers, your mashing system must be capable of continuously recirculating wort with a pump for the duration of the mash without sticking. The flow rates in the chart below are **minimum** values.

Finished Batch Size gal (L)		Minimum Flow GPM (LPM)	
5	(19)	0.5	(2.8)
10	(38)	0.75	(3.8)
15	(57)	1.25	(4.75)
20	(76)	1.5	(5.7)
32	(121)	2.25	(8.5)

Figure 1.

Important: Grain bed flow rates are highly dependent on crush quality and mash tun geometry. Move to a coarser crush if you are not able to achieve the above flow rates. It is also recommended that you allow a 10 min dough-in prior to turning on the pump. This allows air to purge from the grain bed and for the grain to fully absorb the water.

Controls and Connections: Single Element Controller:

Figure 2.

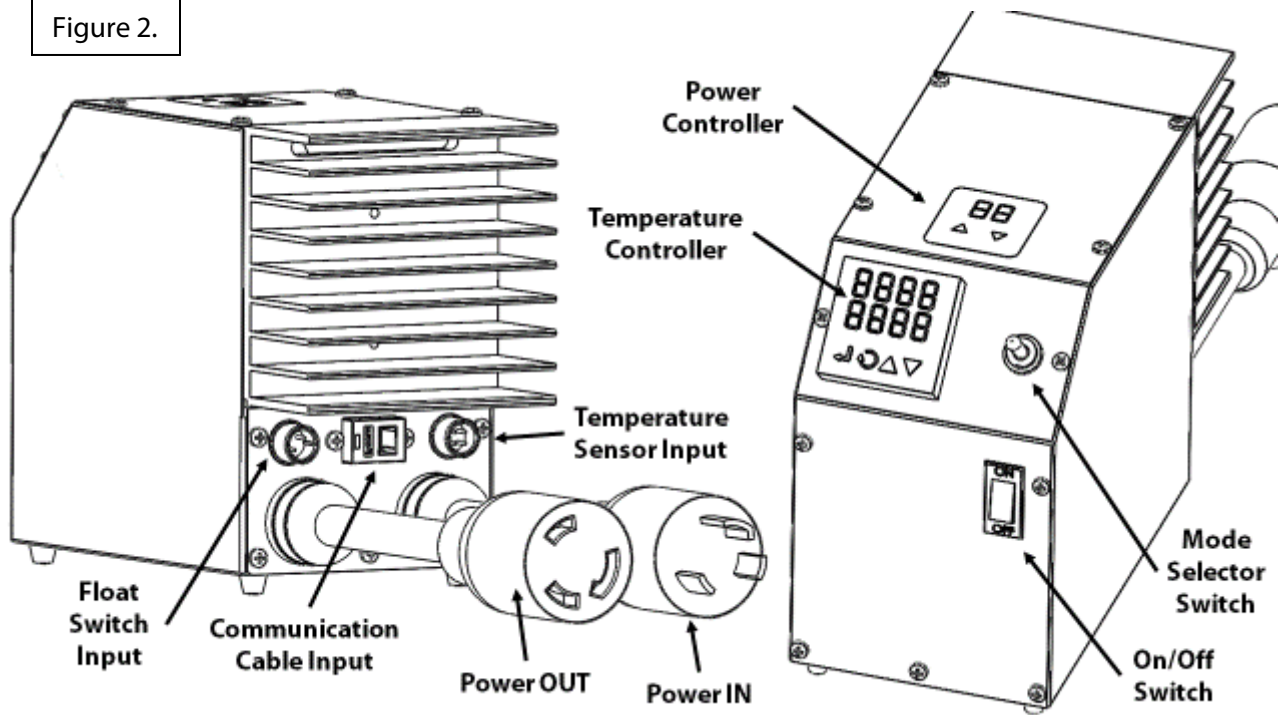

Dual Element Controller:

Figure 3.

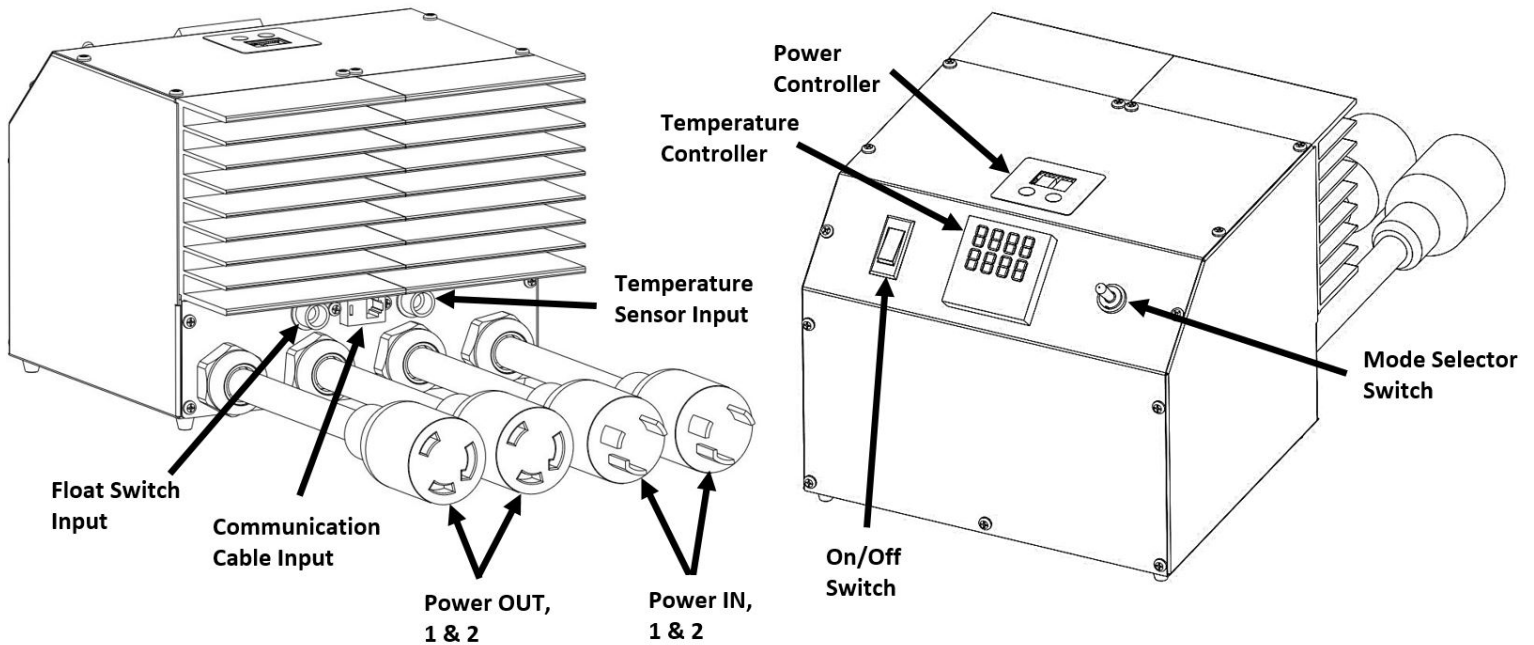

Assembly:

A list of components included with your Electric TOWER of POWER™ temperature control module follows as well as the basic tools required for assembly. Please carefully review the lists below to ensure you received all of the correct parts and have the required tools prior to assembly.

Figure 4.

Parts List:

Item	Quantity	Item	Quantity
Temperature Control Module	1	Power Cable	1
RTD Sensor	1	HLT Label	1
Sensor Cable	1	Mash Label	1
Sensor O-Ring	1	O-Ring Retainer	1
Adapter Bushing	1	½-20 Stainless Steel Jam Nut	1

Required Tools:

Wrench



#2 Phillips Screwdriver

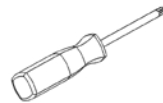

Sensor Installation:

For RIMS mash tuns, install the temperature sensor directly in the wort recirculation path immediately after the heat source (see Figure 1). Brewers using the RIMS Rocket™ should reference the RIMS Rocket™ Owner's Manual for detail instructions on installing the temperature sensor.

For installation of temperature sensor in Hot Liquor Tanks, a ½" inch hole is required. Temperature sensors can be installed in the existing BrewMometer™ hole in Blichmann Engineering BoilerMaker™ kettles. Install the O-ring and retainer on to the temperature sensor and fasten to the kettle with the supplied ½-20 nut.

Important: Installing the temperature sensor directly in the mash tun will result in instability and severe overshooting of mash temperature. Always install the temperature sensor in the recirculation path of the mash tun as close to the heat source as possible.

Tip: Install the O-ring and retainer on the temperature sensor before installing in fitting or kettle.

Tip: Use the optional temperature sensor fitting, part number BE-000268-00, for inline sensor installation.

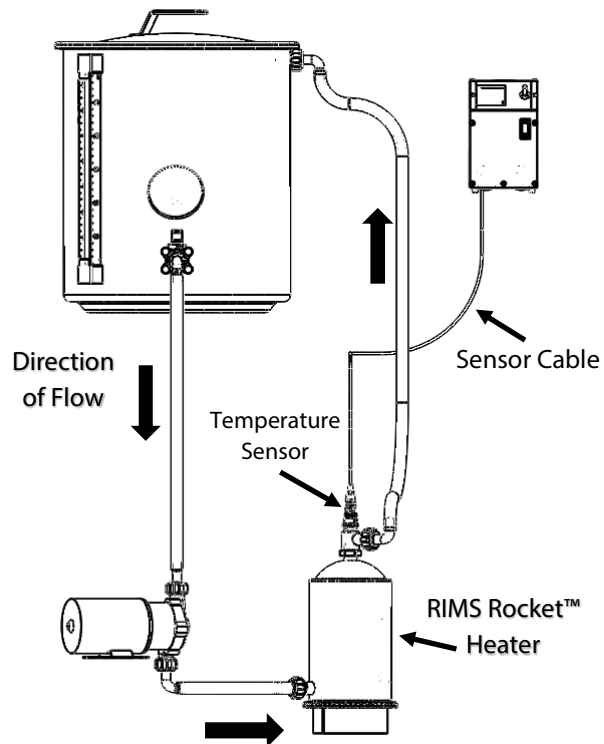
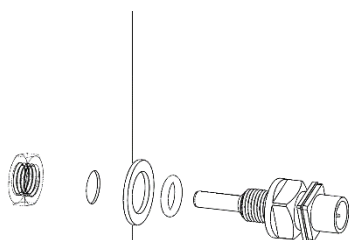
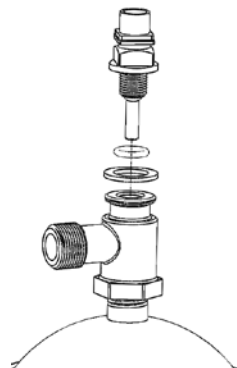

Figure 5.



Hot Liquor Tanks



Optional Fitting
(BE-000268-00)

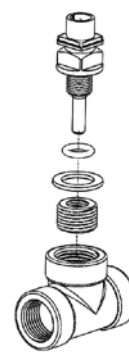

½ NPT T-Fitting
with supplied bushing

Power Connection:

The Electric TOWER of POWER™ temperature control module was designed for use with the BoilCoil™ electric immersion heater and RIMS Rocket™ electric recirculation heater. Although the temperature control module may be compatible with other heating elements, its performance has been optimized for use with Blichmann Engineering™ products.

Warning: Before proceeding, verify the Electric TOWER of POWER™ is disconnected from any and all power sources.

First connect the heater cord to the electric immersion heater. Next connect the male end of the heater cord to the female terminal on the temperature control module. Repeat this step if for the second heating element if using the Dual Element Controller. Connect the female end of the power cord(s) to the male terminal of the temperature control unit and lastly, connect the male end of the power cord(s) to a GFCI power source. Always connect your Electric TOWER of POWER™ temperature control module in this order.

The 240V model of the Electric TOWER of POWER™ temperature control module is equipped with L6-30 connections. Blichmann Engineering™ offers six optional power cord adapters to adapt common 240V outlets to an L6-30R connection.

Warning: The Electric TOWER of POWER™ temperature control module is only to be used in conjunction with a Ground Fault Circuit Interrupter (GFCI) protected power source. If you are uncertain about the status of your power source contact a licensed and qualified electrician familiar with National Electric Code standards before proceeding. Operating the Electric TOWER of POWER™ temperature control module in any fashion other than described in this manual can result in personal property damage, injury, electrocution, or death.

Adaptors available for purchase from Blichmann Engineering™ for receptacles as shown below

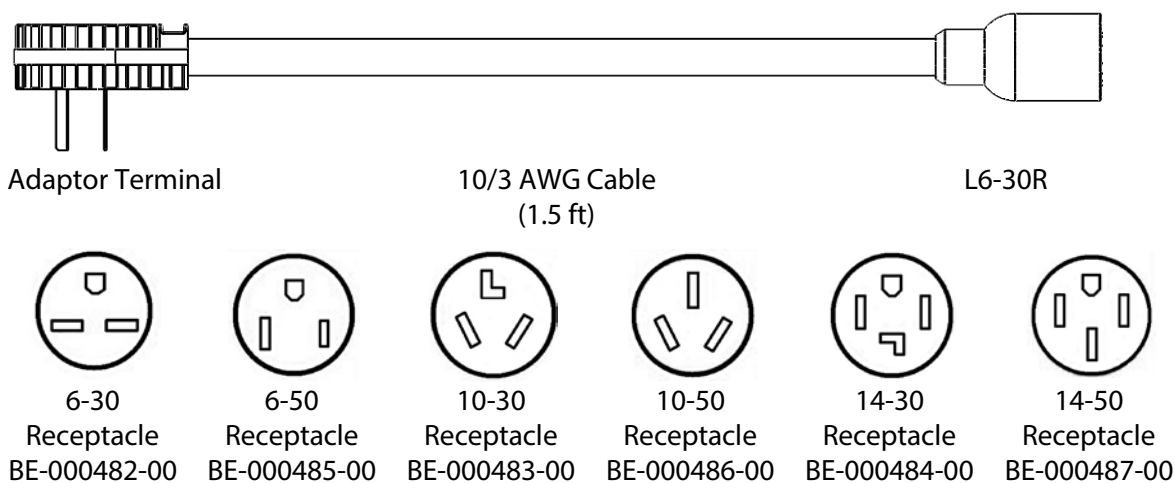

Figure 6.

Operation:

Warning: The Electric TOWER of POWER™ temperature control module is only to be used in conjunction with a Ground Fault Circuit Interrupter (GFCI) protected power source. If you are uncertain about the status of your power source contact a licensed and qualified electrician familiar with National Electric Code standards before proceeding. Operating the Electric TOWER of POWER™ temperature control module in any fashion other than described in this manual can result in personal property damage, injury, electrocution or death.

Warning: Inspect all cables, wires, and connectors for wear and/or damage before every use. Do not use if cables, wires, and/or connections are damaged, loose, or worn. Replace damaged and worn parts with genuine Blichmann Engineering™ parts available from your retailer.

Warning: The 240V model of Electric TOWER of POWER™ temperature control module is rated for use with electric heaters up to 6000 watts. The 120V model of Electric TOWER of POWER temperature control module is rated for use with electric heaters up to 2250 watts. Never exceed 25 amps with the 240V model and 20 amps with the 120V model.

Getting Started

The BoilCoil™ and RIMS Rocket™ heaters require the use of a power control device capable of de-energizing the heater coil to operate safely. The BoilCoil™ and RIMS Rocket™ heaters were designed specifically for use with the Blichmann Engineering™ TOWER of POWER™ temperature control module. Although the BoilCoil™ may be compatible with other commercially available brewing controllers, the TOWER of POWER™ temperature control module provides the ultimate in convenience, accuracy, and precision.

Temperature Control

To control the temperature of your mash tun or hot liquor tank, input the desired set temperature using the up or down buttons and press enter. After entering the set temperature, move the mode selector switch to the "Auto" position.

Enter



Next



Up



Down

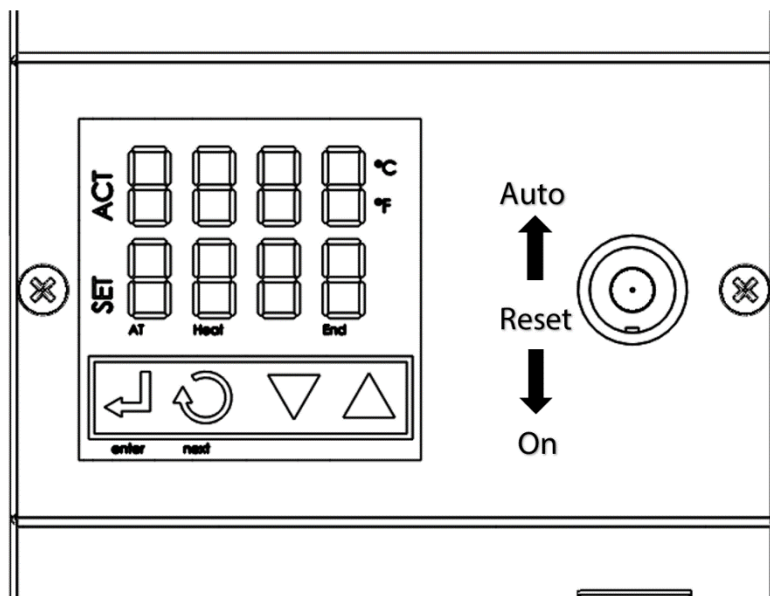
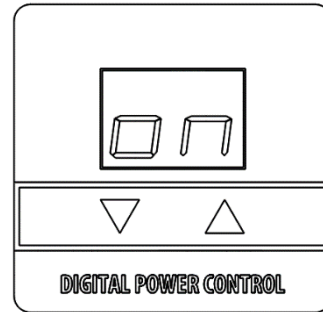

Figure 7.

Power Control

The TOWER of POWER™ temperature control module is capable of modulating the power output to the heater using a digital power control. This feature is active in both the temperature control (“Auto”) mode and in the “On” mode. Use the digital power control to fine tune boil rates in the boil kettle. Digital power control is especially useful with RIMS heaters in the event of slow flow rates.

To activate the power control mode press both the up and down buttons simultaneously and release until the display show “on” (see Figure 5). Next adjust the power in one percent increments using the up and down buttons.



TIP: Press the Up and Down buttons simultaneously to toggle between 0% and 100% power.

Controller at zero percent power

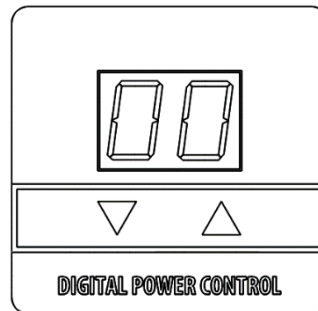

Low Level Float Switch activated

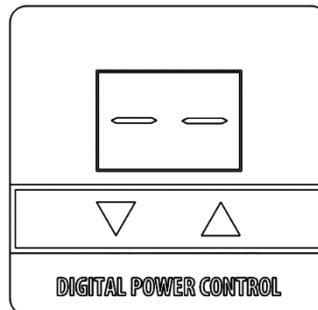

Figure 8.

Communication Cable:

Advanced Operation Mode

(Auto Ramp/Soak/Monitoring)

The TOWER of POWER™ temperature control module is capable of downloading ramp/soak profiles as well as real time data observation and logging. This mode of operation requires the purchase of an optional RJ12->USB communication cable (purchase through your retailer) and downloading the free Blichmann Engineering™ TOP-Link interface software from our web page. Please note that a plain USB cable will not work and may damage the controller.

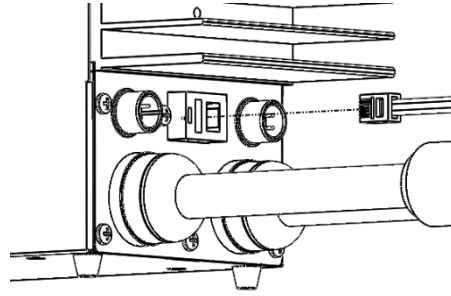

Figure 9.

Important: This software is only available for Windows platform. It is not available for Mac or portable devices.

Features: The auto ramp/soak feature will allow you to automatically follow a user-programmed mash profile. Up to 8 individual mash profiles can be stored in the controller (up to 4 rests each) and they can also be linked together for very complex mash profiles. In addition, the user can save an unlimited number of mash profile files on your computer and recall those as needed. System parameters, such as units, calibration offset, resetting to factory defaults can easily be made through the software. Lastly, the user can graph the controller output and export to a CSV file for documenting the brew day.

For a preview of the software, and for instructions on operation, view our online tutorial video at the page listed below. A written manual is not available for advanced operation mode.

<http://www.blichmannengineering.com/products/tower-power>

Optional Safety Float Switch

The TOWER of POWER™ temperature control module can be equipped with an optional safety float switch to protect heating elements from being energized when not submerged in liquid. Install the safety float switch according to the instructions supplied with the float switch. Connect the cable that's supplied with the float switch to the electric temperature control module and the float switch. When the liquid level falls below the position of the switch, power from the controller is shut off.

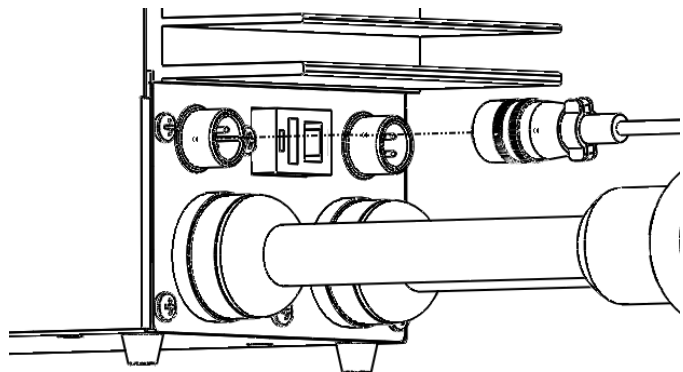

Figure 10.

Maintenance

The Electric TOWER of POWER™ temperature control module requires little maintenance. Inspect fasteners, wires and hoses regularly and replace as needed ONLY with genuine Blichmann Engineering™ parts. Parts can be ordered through your retailer. After brewing, wipe any drips off with ordinary soap and a soft sponge.

Appendix

To change units from deg F to deg C:

- Press the Enter and Next key simultaneously to unlock the controller
- Press and hold the Enter key for 3 sec and Next buttons simultaneously then release
- Press Enter for 3 sec and release
- Press Next until you see tPUn
- Press up/down arrow to change to C
- Press Enter to accept
- Press Enter again to exit setup mode

To relock the controller to prevent accidental changes to the settings (recommended):

- Press the Enter and Next key simultaneously and immediately release
- Repeat previous step
- Press Next until you see LoC
- Press up/down arrow to change to LoC2
- Press Enter to accept

NEVER:

- NEVER leave this equipment unattended
- NEVER allow children near this equipment
- NEVER heat cooking oil with this equipment
- NEVER operate on soft, uneven surfaces like dirt, gravel, or asphalt
- NEVER use near or with combustible chemicals, gasoline, or other flammable vapors or liquids
- NEVER bypass GFCI circuit protection
- NEVER operate any equipment with frayed or damaged power cables
- NEVER expose electrical connections to moisture
- NEVER modify or alter the supplied electrical cables or connectors
- NEVER operate controller with higher than rated voltage
- NEVER unplug heater when energized
- NEVER energize the heater without the heating coils fully submerged

ALWAYS:

- ALWAYS use controller with rated voltage
- ALWAYS unplug controller when powered off
- ALWAYS use on level and stable hard surfaces
- ALWAYS connect to a GFCI circuit
- ALWAYS check power cables and connectors for signs of damage or wear prior to each use
- ALWAYS check that all fasteners are properly tightened prior to each use
- ALWAYS use with correct wattage heater
- ALWAYS use genuine Blichmann Engineering™ replacement parts
- ALWAYS unplug before moving
- ALWAYS wear appropriate personal protective equipment, such as gloves, clothing, and footwear to prevent burns and scalds

Blichmann Engineering Product Warranty

A. Limited Warranty

1. Blichmann Engineering warrants to the original purchaser that this product will be free from manufacturing defects in material and workmanship for a period of one (1) year from the date of purchase by the customer. Proof of purchase is required. Blichmann Engineering's obligation to repair or replace defective materials or workmanship is the sole obligation of Blichmann Engineering under this limited warranty.
 2. This product is for home use only. The limited warranty covers only those defects that arise as a result of normal use of the product and does not cover any other problems, including, but not limited to, those that arise as a result of:
 - a. *Improper maintenance or modification;*
 - b. *Damage due to incorrect voltage or improper wiring by customer;*
 - c. *Operation outside of the product's specifications;*
 - d. *Carelessness or neglect to operate the product in accordance with instructions provided with the product;*
 - e. *Damaging the tamper label on the product;*
 - f. *Damage by over-tightening the fasteners;*
 - g. *Failure to follow cleaning and / or maintenance procedures; or*
 - h. *Exceeding published operational temperatures.*
 3. Blichmann Engineering reserves the right to request delivery of the defective component for inspection before processing the warranty claim. If Blichmann Engineering receives, during the applicable warranty period, notice of a defect in any component that is covered by the warranty, Blichmann Engineering shall either repair or replace the defective component with a new or rebuilt component at Blichmann Engineering's option.
 4. Blichmann Engineering must be notified within seven (7) days of the delivery date of any shipping damage. Customer is responsible for shipping damage outside of this time period. Approval for return must be provided by Blichmann Engineering prior to any return. Customer is responsible for keeping all original packaging material for warranty returns. Blichmann Engineering is not responsible for damage from improperly packaged warranty returns, and these repair costs will be the sole responsibility of the customer. Shipping costs for warrantee returns are covered only for the contiguous United States.
 5. Blichmann Engineering's limited warranty is valid in any country where the product is distributed.
-

B. Limitations of Warranty

1. Any implied warranty that is found to arise by way of state or federal law, including any implied warranty of merchantability or any implied warranty of fitness, is limited in duration to the terms of this limited warranty and is limited in scope of coverage to this warranty. Blichmann Engineering disclaims any express or implied warranty, including any implied warranty of fitness for a particular purpose or merchantability, on items excluded from coverage as set forth in this limited warranty.
 2. Blichmann Engineering makes no warranty of any nature beyond that contained in this limited warranty. No one has authority to enlarge, amend, or modify this limited warranty, and Blichmann Engineering does not authorize anyone to create any other obligation for it regarding this product.
 3. Blichmann Engineering is not responsible for any representation, promise, or warranty made by any independent dealer or other person beyond what is expressly stated in this limited warranty. Any selling or servicing dealer is not Blichmann Engineering's agent, but an independent entity.
-

C. Limitations of Liability

1. The remedies provided in this warranty are the customer's sole and exclusive remedies.
 2. Except for the obligations specifically set forth in this warranty, in no event shall Blichmann Engineering be liable for direct, indirect, special, incidental, or consequential damages, whether based on contract, tort, or any other legal theory and whether or not advised of the possibility of such damages.
 3. This warranty does not cover, and in no event shall Blichmann Engineering be liable for, travel, lodging, or any other expense incurred due to manufacturing defects in material and workmanship, or any other reason.
 4. Any performance of repairs after the warranty coverage period has expired or performance of repairs regarding anything excluded from coverage after this limited warranty shall be considered good-will repairs and they will not alter the terms of this limited warranty, or extend any warranty coverage period.
 5. Venue for any legal proceedings relating to or arising out of this warranty shall be in Tippecanoe County, Indiana, United States, which courts will have exclusive jurisdiction.
-

D. Local Law

1. This warranty gives the customer specific legal rights. The customer may also have other rights that vary from state to state in the United States or other countries.
2. To the extent that this warranty is inconsistent with local law, it shall be deemed modified, only to the extent necessary to be consistent with such local law.